

1. **True Strobe Display** Pattern in the ring of LEDs rotates left if the note is flat, and rotates right if the note is sharp.
2. **Sharp/Flat LEDs** These activate if the note is more than 50 cents out of tune. These are only active in "open tuning" mode.
3. **LED Note Display** Displays the note name in chromatic mode, or the string number in open tuning mode.
4. **A4 ≠ 440** Illuminates when the A reference is set to any value other than 440.0 Hz. The range of A4 is 300.0 to 599.9 Hz in .1 Hz increments.
5. **Drop Tuning Indicator** You may drop the tuning up to 9 semitones.
6. **Mode Indicator** Six modes total. All except CHRM (chromatic) are fully programmable. They may be set as an open tuning or chromatic, and each note may be offset ±50.0 cents in .1 cent increments.
7. **Configurable Output** Normal mode is 100% true bypass with muted output. An internal switch can set it to pass the signal through when tuning.
8. **Mode/Calibrate Button** Changes mode in normal operation. Hold down during power on to change the A4 reference.
9. **Mode/Drop Tuning Button** Changes mode in normal operation. Hold down during power on to change the number of semitones to drop.

Table of Contents

Front Panel Description	1
Quick Start Guide	1
Chromatic/Guitar Modes	2
Output Configuration	2
Tuning Presets	3
ST-300 Features	3
Tuning Tips	4
Changing the Reference Pitch	4
Flat Tuning	4
Resetting the Tuner	4
Custom Tunings & Temperaments	5
Editing An Open Tuning	5
Editing A Temperament	6
Capturing a Custom Tuning	7
Appendix A - Pre-Programmed Temperaments	9

Using the Tuner - Quick Start

1. Plug the ST-300 into your signal chain. A plug must be inserted into the input jack for the tuner to operate.
2. Optionally connect a 9 Volt external power source. The ST-300 will run for 12 hours on an alkaline battery, enough for about 1,000 tune ups.
3. Stomp on the foot switch. When the tuner is on, the output is muted. When the tuner is off, the signal is passed straight through with absolutely no load on the signal. It is 100% true bypass. NOTE: The ST-300 can be configured to pass the signal to the output jack while the tuner is on. See page 6.
4. Play a note and observe the pattern in the LEDs. The direction of rotation indicates whether the note is sharp or flat. The farther out of tune, the faster the pattern will rotate. When stationary, the note is perfectly in tune. When moving slowly, you are still within a fraction of a cent.

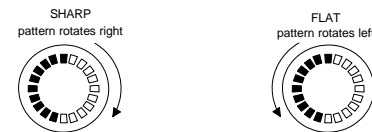

Chromatic/Guitar Modes

Chromatic Mode

In chromatic mode, the tuner responds to all 12 notes of the chromatic scale. The note display in the center of the LED ring will show the letter of the note.

Guitar/Bass Modes (Open Tuning Modes)

In guitar mode, the tuner only selects notes that are defined for the particular tuning. For example, standard guitar tuning has six notes, E4, B3, G3, D3, A2 and E2.

The note display in the center of the LED ring will show the string number instead of the note name.

We also refer to this mode of operations as "open tuning mode".

Output Configuration

The output can be set to mute while tuning, or to pass the signal through while tuning. There is a 2-position DIP switch inside the tuner near the battery compartment as shown in the illustration below:

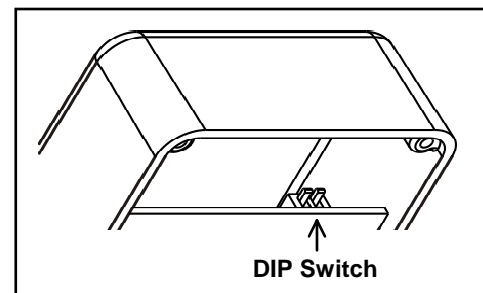

100% True Bypass: Both switches in the UP position.

The output is muted when the tuner is on. When the tuner is off the signal is completely disconnected from the tuner circuitry and is directly connected to the output jack.

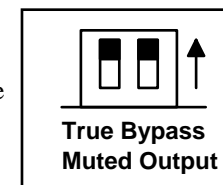

Pass-through Modes: With both switches in the down position, the tuner will pass the signal through to the output while the tuner is on.

With the switches in this position there are two options:

Pass-through Mode 0: The input signal is always passed through to the output. The footswitch turns the tuner on and off.

Pass-through Mode 1: The tuner is always on. The footswitch mutes the output. Not recommended when powering the tuner from a battery.

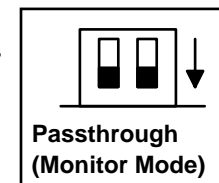

Setting the Pass-through Mode:

1. With the tuner on, press and hold the footswitch.
2. While holding the footswitch down, press the right MODE button (the FLAT button). The number 0 or 1 will appear in the note display. Pressing the FLAT button will toggle between the two modes.
3. When the desired mode (0 or 1) is displayed, release the footswitch.

Tuning Presets

The ST-300 has six different tuning settings. The setting currently selected is indicated by the row of six LEDs at the bottom of the display panel. The first setting, labeled "CHRM" is always chromatic, equal temperament.

All of the remaining 5 tunings can be programmed by the user to be an open tuning with up to 9 strings, or set to chromatic mode. Each note in a tuning, be it an open tuning or chromatic mode, may be offset by ± 50 cents in .1 cent increments.

The table on the next page shows the settings pre-programmed into the ST-300. You can easily program these yourself to any custom tuning you desire. See page 18 for instructions.

The setting at CST1 is left as standard guitar to make it quick and easy to program your own custom offsets. See page 18 for programming instructions, and page 26 for how to capture the tuning of an instrument. If you need help with programming, call our tech support department at 800-811-0272 ext. 2.

Use the MODE buttons to select the desired preset.

GUIT	
String #	Note
1st	E4
2nd	B3
3rd	G3
4th	D3
5th	A2
6th	E2

BASS	
String #	Note
1st	G2
2nd	D2
3rd	A1
4th	E1
5th	B0

CST1 (Standard)	
String #	Note
1st	E4
2nd	B3
3rd	G3
4th	D3
5th	A2
6th	E2

CST2 (Drop D)	
String #	Note
1st	E4
2nd	B3
3rd	G3
4th	D3
5th	A2
6th	D2

CST3 (6 String Bass)	
String #	Note
1st	C3
2nd	G2
3rd	D2
4th	A1
5th	E1
6th	B0

All of these 5 settings are user programmable and can have up to 9 strings, or can be set to a chromatic temperament. See page 18 for instructions on how to program these yourself.

ST-300 Features

- **True Strobe Display** - Easy to read display instantly shows the slightest difference in pitch of the note played from the indicated note. The ring of LEDs is a true stroboscope, driven directly by the analog input signal and a precision internal frequency reference. This gives zero latency and instantly shows the slightest tuning error.
- **Flexible Output** - The output of the ST-300 can be set to mute the signal or pass it through while tuning. See 6.
- **Extreme Accuracy** - The internal timing generator is calibrated at the factory to maintain a precision of ± 0.02 cents.
- **Chromatic Mode** - Permits tuning to any of the 12 notes from C0 to C8, in any temperament. In this mode the note display shows the note name (A-G#).
- **Open Tuning Modes** - In open tuning mode, the tuner only selects notes that are defined for the particular tuning, and the note display shows the string number instead of the note name.
- **Power On Restore** - The ST-300 remembers the settings for mode, drop tuning and A4 changes. No battery is necessary.
- **Flat Tuning** - Lowers all pitches up to nine semitones.
- **Reference Pitch Change** - By default, the tuner uses A4=440Hz as the reference pitch. This can be changed to any value from 300.0 Hz to 599.9 Hz.
- **Temperaments** - The ST-300 can operate in the equal temperament or any 12 note temperament the user desires. The ST-300 can store a total of 5 different temperaments, in addition to the equal temperament.
- **External Power In** - The Turbo Tuner ST-300 accepts an external 9 VDC supply with the following polarity:

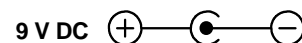

Any 9 Volt adapter designed for stomp boxes will work fine. You can connect it to either of the power jacks on the top side of the tuner.

- **Power Out** - If you use an external power supply you may use the extra power jack to daisy-chain power to other pedals.
- **Low Battery Indication** - When there is about an hour of battery life remaining, a low battery warning is shown on the note display every 2 minutes.

The low battery indication is the following 5 characters displayed in rapid sequence:



Tuning Tips

The Turbo Tuner is designed to respond quickly to the notes from your guitar without resorting to adjusting the volume or plucking the string differently than you normally would when playing.

The single most important tip:

Mute the strings not being tuned by resting your fingers on them. This will eliminate sympathetic vibrations and give a quicker response and a cleaner pattern in the strobe display.

For the fastest tuning, follow these tips:

1. Turn the tuning pegs as fast as you want. The Turbo Tuner will track the note instantly and keep up no matter how fast you change the pitch.
2. Don't worry about trying to get the rotation to stop completely. As long as it's moving slowly you are within a fraction of a cent.

Changing the Reference Pitch

The default reference pitch is A4=440 Hz. This can be changed in .1Hz increments to any value from 300.0 Hz to 599.9 Hz.

To change the reference pitch, press and hold the CAL button while turning the tuner on. The A4 LED and LED corresponding to the currently selected mode will flash, and the current setting of A4 will scroll through the note display. For example, assuming the tuner's reference is set to 440.0Hz, the display will scroll through the following sequence:

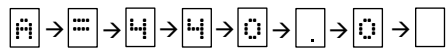

You may then press the CAL button to scroll through the current setting, and use the FLAT button to change each digit.

After the desired value has been entered, press the CAL button to scroll through the display until the note display is blank, then press the FLAT button. The tuner will now resume normal operation.

The default A4 reference frequency is set when the tuner is in CHRM (chromatic) mode. For the five programmable modes, you can set them to this default frequency by setting the first digit of the frequency to "D" (for default).

Whenever the A4 reference is set to anything other than 440.0 Hz, the A4 LED will be illuminated.

Flat Tuning

Flat tuning lowers the pitch of all notes below standard tuning from one to nine semitones. To change the number of flats, hold the FLAT button while turning the tuner on. The Flat LED and LED corresponding to the currently selected mode will flash, and the note display will show the number of flats. Pressing the FLAT button will advance the number of flats.

The numbers will scroll from 0-9 in CHRM mode., and if you are setting one of the five programmable mode it will scroll 0-9 then "D". The "D" tells it to use the default setting. The default is set when the tuner is in the CHRM mode.

Pressing the CAL key will save the number of flats and return to normal operation.

Note that each of the five programmable modes can have it's own drop tuning setting, or it can use the default value (set when the tuner is in the CHRM mode).

When the number of flats is anything other than zero, the Flat LED is illuminated.

Resetting the Tuner

You can reset the tuner by holding down both mode buttons and pressing the footswitch. A number from 0-4 will appear in the note display. Each press of the footswitch cycles to the next number. Release the mode buttons to perform the desired reset action as shown below:

0: No action. Tuner resumes normal operation.

1. Sets the mode to Chromatic, sets A4 to 440Hz, clears any flats and sets the pass-through mode to mode 0.
2. Full Reset. This will restore all the factory defaults including the tunings and temperaments. **ANY USER DEFINED TUNINGS AND TEMPERAMENTS WILL BE ERASED.** During the loading process the note display will read "L#"
3. Same as above, but loads the tunings for True Temperament necks instead of the defaults. These are described in Appendix B. During the loading process the note display will read "t#"
4. Displays the serial number and firmware revision.

Custom Tunings & Temperaments

You may edit the notes of any preset except Chromatic. Each preset may be configured as an open tuning with up to 9 strings, or a temperament.

For a temperament, the tuner is in chromatic mode where it responds to all 12 notes of the scale and displays the note letter. For an open tuning, the tuner only selects notes that are defined for the particular tuning, and displays the string number.

• Entering Edit Mode

To put the tuner in edit mode, select the preset you wish to change using a MODE button, and while holding down the MODE button, press the other MODE button.

The LED indicator for the preset about to be altered will be flashing. Check to make sure the selected preset is the one you want to change. If not, turn the tuner off then back on and try it again.

Upon entering edit mode, the note display will show one of these two values:

- ∞ This is "o" and means the preset is an open tuning.
- ♯ This is "t" for temperament, and means the preset is currently a temperament.

Pressing the right MODE button will toggle between open tuning mode (∞) and temperament mode (♯). Press the left mode button to proceed.

Each of the 5 presets has a temperament and open tuning associated with it, and editing one has no effect on the other.

Editing An Open Tuning

After entering edit mode as describe above, press the left button when the display reads ∞. The note display will read ♯. This is the string number.

The left button will scroll through the strings of the tuning, and will show one more string than is defined. For example, a standard guitar tuning has 6 strings, and when scrolling through the strings in edit mode, there will be 7. This is so you can add more strings to the tuning if you desire.

Pressing the right button scrolls through the setting for the string. The display starts with the string number, then an = followed by the cents offset in the format +/-nn.n. For example, if you wanted to offset the 5th string of the guitar by +2.0 cents, the display would scroll through the following digits when pressing the right button:

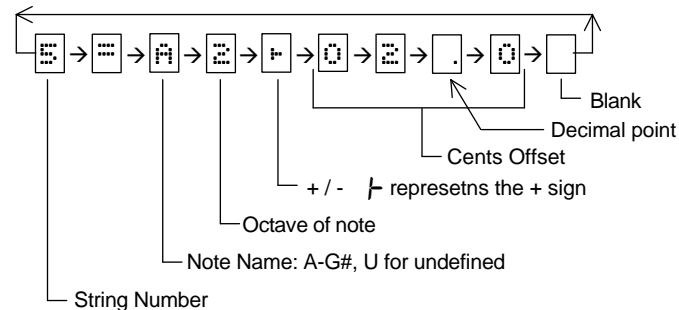

To change a value, use the left MODE button.

To exit edit mode, use the right button to scroll through a note's settings until you reach the end and the display is blank. Then press the left button.

• Adding A String

When scrolling through the strings for a tuning you will notice there is one string more than is defined for the tuning. For example, the GUIT tuning has 6 strings, but when in edit mode there will be a 7th string. If you scroll through the settings for the "7th" string, you will find the note value is U for undefined. If you set the note to anything other than U, the string is added to the tuning.

• Removing A String

Normally there are 12 note values available for a string (A-G#). For the last string in a tuning, there is an additional note, named U for undefined. If you set the note value to U, the string is no longer part of the open tuning. This can only be done to the last string in the tuning.

Quick Reference for Editing An Open Tuning

1. Press both MODE buttons to enter edit mode, and make sure the LED for the preset you wish to edit is flashing
2. If the display reads E press the right button so it reads D .
3. Press the left button. The display will now show the number 1. This means you are ready to edit the note for the first string.
4. Press the right button to scroll through the current settings for the string. The sequence will be an equal sign followed by the note, octave, then the cents offset in the format +/-nn.n . For example, if the note is the 5th string of the guitar and is offset by $+12.3$ cents, the values displayed will be:

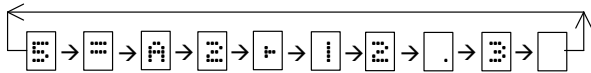

5. Use the left button to change any of the values.
6. At the end of the sequence the display will be blank. Pressing the right button again will bring you back to the string number. Pressing the left button when the display is blank exits program mode and returns to normal operation.

Editing A Temperament

After entering edit mode as describe earlier, press the left button when the display reads E . The note display will now read C . This is the first note in the temperament.

Press the left button to scroll through the 12 notes of the chromatic scale.

Pressing the right button scrolls through the setting for the note. The display starts with the note name followed by the cents offset for that note in the format +/-nn.n . For example, if you wanted to offset C by $+15.6$ cents, the display would scroll through the following digits when pressing the right button:

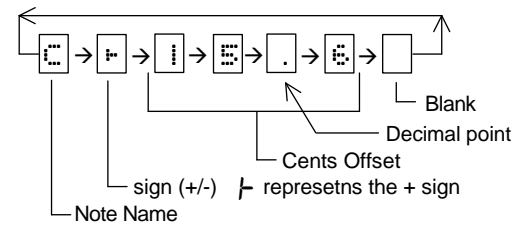

To change a value, use the left MODE button.

To exit edit mode, use the right button to scroll through a note's settings until you reach the end and the display is blank. Then press the left button.

• Quick Reference for Editing A Temperament

1. Press both MODE buttons to enter edit mode, and make sure the LED for the preset you wish to edit is flashing
2. If the display reads D press the right button so it reads E .
3. Press the left button. The display will now show the letter C, the first note in the temperament. You can scroll through the notes using the left MODE button.
4. Press the right button to scroll through the current offset for the note. The sequence will be the note followed by the cents offset in the format +/-nn.n . For example, if the note C is offset by $+15.6$ cents, the values displayed will be:

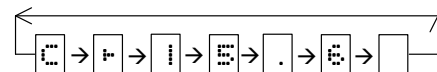

5. Use the left button to change any of the values.
6. At the end of the sequence the display will be blank. Pressing the right button again will bring you back to the note name. Pressing the left button when the display is blank exits program mode and returns to normal operation.

Capturing a Custom Tuning

If you have a certain way of tuning your guitar that offsets the open strings, you can easily capture the tuning of the open strings and store it as an open tuning. You are in effect tuning the tuner to the guitar, and saving the tuning for future use.

1. Enter edit mode. (Refer to page 18 on how to enter edit mode and change the note and offsets.)
2. Set the tuner to the string you wish to capture, then use the right button to scroll through the offset and make sure it's set to 00.0 cents.
3. Set the note and octave, then advance to the sign.
4. Setting the sign: First, play the note. If the pattern rotates to the right, set the sign to +, if to the left, set the sign to -. Use the left button to change the sign, the right button to advance to the cents offset.
5. Advance to the 10's position of the cents offset by pressing the right button. Increase it (by pressing the left button) until the rotation changes direction. Note the number, then push the left button until the number is one less. You want to stop on the number just before the rotation changes directions.
6. Advance to the 1's and .1's position and repeat step 4. You have now recorded the cents offset for that string.

Power Connect Options

The tuner can be configured to turn on when external power is first applied:

1. Unplug the power and remove the battery.
2. Plug a cable into the input jack.
3. Hold the footswitch down for 5 seconds, then release.
4. Hold the left Mode button down (the one labeled "CAL") and plug the power back in.

The tuner should now turn on when your board is first powered up. Note that for this feature to work you must remove the battery, and a cable must be plugged into the input jack.

To disable this feature, reset the tuner or re-load the factory defaults as described on page 16.

USB

The ST-300 has a USB port. This can be used to set up custom tunings and other tuner parameters, and to upgrade the firmware should there be any future enhancements to the product.

USB operation is beyond the scope of this manual. Instructions for using the USB port can be found on our website at www.turbo-tuner.com/usb.

Appendix A - Pre-Programmed Temperaments

The five tuning modes of the ST-300 can be set to a temperament or open tuning. By default they are set to the open tunings shown on page 9.

You can set a tuning mode to a temperament as described on page 18-19. Upon entering edit mode the note display will read either \square ("o" for open tuning) or t ("t" for temperament). If it is set to 'o', use the left button to select 't', then turn the power off and back on. You can switch back to an open tuning using the same method only selecting 'o'.

The 5 temperaments pre-programmed into the ST-300 are completely independent of the 5 open tunings. They are fully editable and any changes made to a temperament will have no effect on an open tuning.

The following tables show the temperaments that come pre-programmed into the ST-300:

The temperaments in CST1 - CST3 are for True Temperament™ necks. For more information, please visit their website at www.truetemperament.com.

CST1 Thidell Formula 1	
Note	Offset
C	+2.0
C#	-4.0
D	+2.0
D#	-4.0
E	-2.0
F	0.0
F#	-4.0
G	+4.0
G#	-4.0
A	0.0
A#	-4.0
B	-1.0

CST2 D.W.G.	
Note	Offset
C	+5.9
C#	+1.4
D	+2.0
D#	+0.6
E	-2.0
F	+7.8
F#	-1.4
G	+3.9
G#	+0.2
A	0.0
A#	+3.9
B	0.0

CST3 Meantone Blues	
Note	Offset
C	0.0
C#	0.0
D	4.8
D#	0.0
E	-2.6
F	0.0
F#	0.0
G	7.2
G#	0.0
A	0.0
A#	0.0
B	-4.0

GUIT Just Intonation	
Note	Offset
C	15.6
C#	-13.7
D	19.6
D#	31.3
E	2.0
F	13.7
F#	5.9
G	17.6
G#	-11.7
A	0.0
A#	33.2
B	3.9

BASS (Equal Temperament)	
Note	Offset
C	0
C#	0
D	0
D#	0
E	0
F	0
F#	0
G	0
G#	0
A	0
A#	0
B	0

Appendix B True Temperament Open Tunings

The ST-300 can be loaded with open tunings for the True Temperament™ necks, as shown below.

CST1 (FORMULA 1)	
String #	Note
1st	E4-1.0
2nd	B3-1.0
3rd	G3+4.0
4th	D3+2.0
5th	A2
6th	E2-2.0

CST2 (DWG)	
String #	Note
1st	E4-2.0
2nd	B3
3rd	G3+3.9
4th	D3+2.0
5th	A2
6th	D2-2.0

CST3 (TT Low Tune)	
String #	Note
1st	B3-3.0
2nd	F#3-3.0
3rd	D3+2.0
4th	A2
5th	E2-2.0
6th	B1-4.0

To load these tunings, start with the tuner off, then while holding down both MODE buttons, press the footswitch repeatedly until the number 3 appears in the display. Release the MODE buttons and the presets shown above will be loaded. This will restore all the factory defaults including the tunings and temperaments. ANY USER DEFINED TUNINGS AND TEMPERAMENTS WILL BE ERASED.

You can load the standard open tunings shown on page 9 by cycling power while holding down both MODE buttons until the number 2 is in the display.

Warranty

Sonic Research Inc. (SRI) warrants the ST-300 to be free from defects in materials or workmanship for a period of one year from the date of purchase. If, during this period, any device in normal use fails to function due to a fault in materials or workmanship, Sonic Research will, at its sole discretion, either repair or replace the device, and will ship the repaired original or reconditioned replacement device back to the original purchaser, free of charge. The cost of shipping any merchandise to Sonic Research for warranty service is the responsibility of the buyer. All returns must be accompanied by a return authorization number. Please contact Sonic Research at 1-800-811-0272 for assistance. This warranty does not cover damage caused by accident, misuse, attempted alterations or repairs, or defective batteries.

SRI reserves the right to make changes in design or make additions to or improvement upon this product without any obligation to install the same on products previously manufactured.

SRI shall not be liable for any consequential damages, including without limitation damages resulting from loss of use. Some states do not allow limitation of incidental or consequential damage, so the above limitation or exclusion may not apply to you. This warranty gives you specific legal rights, and you may have other rights which vary from state to state.

FCC Statement of Conformity

This equipment has been tested and found to comply with the limits for a Class B digital device, pursuant to Part 15 of the FCC Rules. These limits are designed to provide reasonable protection against harmful interference in a residential installation. This equipment generates, uses, and can radiate radio frequency energy and, if not installed and used in accordance with the instructions, may cause harmful interference to radio communications. However, there is no guarantee that interference will not occur in a particular installation. If this equipment does cause harmful interference to radio or television reception, which can be determined by turning the equipment off and on, the user is encouraged to try to correct the interference by one or more of the following measures:

- Reorient or relocate the receiving antenna.
- Increase the separation between the equipment and receiver.
- Connect the equipment into an outlet on a circuit different from that to which the receiver is connected.
- Consult the dealer or an experienced radio/TV technician for help.

Contact Information

The Turbo Tuner is manufactured in the USA by:

Sonic Research Inc.
711 S. Carson Street, Suite 6
Carson City, Nevada 89701
(775) 883-4831
www.sonic-research.com

©2004-2016 Sonic Research Inc.